

EasyWash gantry car washes

---



**“How can I be successful  
even with a small car wash  
business?”?**

---

With the EasyWash gantry car washes.

---

 **WashTec**



“Who offers the solutions my customers expect from me?”

## WashTec provides the answers for your business.

The car wash business has high demands, and no one knows this as well as WashTec. As the inventors of the gantry car wash, we revolutionised the car wash market – and have since led the way for more than 50 years, providing highly efficient washing technology, optimised chemicals and comprehensive services for your business.

### Our approach is simple:

In everything we do, we not only focus on achieving the perfect result, we make the people we serve our top priority. Everyone expects to have a clean car after a wash. Results are important, but so is how we get there:

- » **We understand your needs.**  
We listen carefully to what your customers say they want – and to your requirements as a business.
- » **We meet – and exceed – expectations.**  
Our solutions are consistently geared towards your wishes and expectations, and they more than meet these.
- » **We support your business.**  
We provide a car wash experience and finish that impresses your customers and earns their loyalty, giving you repeat business.
- » **We improve your cost-efficiency.**  
We offer robust, low-maintenance, durable technology and extremely efficient washing chemicals – for maximum profit at minimal cost.





## EasyWash: Advantages for you and your customers.

- Minimal investment and low operating costs for a profitable washing business
- Ideal for service washes and low throughput
- Optimum use of space thanks to a very compact design



# “How can I get even more profit from my car wash business?”



# 4DIMENSIONS for a successful car wash business.

Is there such a thing as a gantry car wash that provides a thorough clean in less than seven minutes? That's easy to use and impresses with a fantastic car wash experience?

The EasyWash gantry car wash combines all of these dimensions in one incredible car wash experience for your customers and for your business as well, because it makes car washing a lucrative endeavour.

Indeed, there is, because we invented it: the EasyWash. Like no other system, the EasyWash meets your customers' high requirements for washing quality and speed, ease of use and design – the four parameters that we at WashTec call the **4DIMENSIONS** of the modern car wash.

With 4DIMENSIONS, discover the new dimensions of car washing and use the EasyWash to guarantee the greatest customer satisfaction and a successful car wash business.

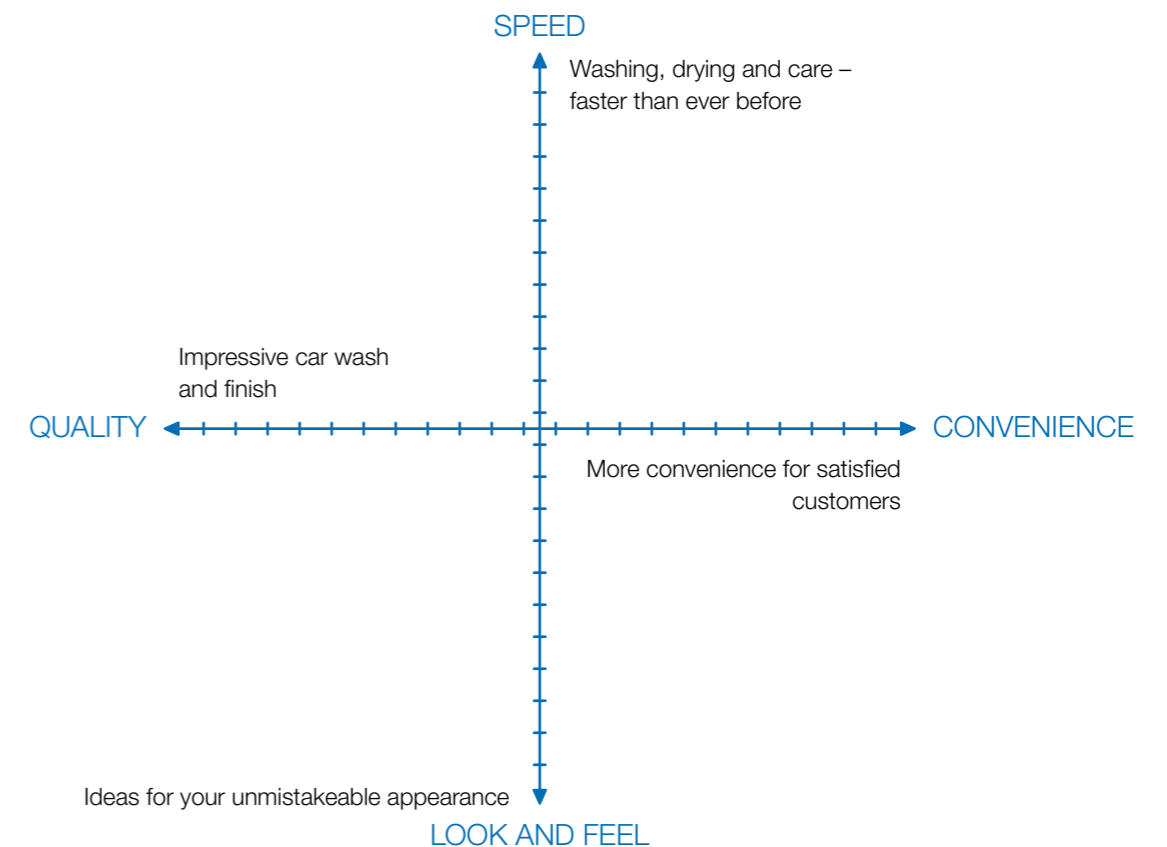

**4DIMENSIONS for every requirement.**  
 The 4DIMENSIONS make tailored solutions for every requirement possible. As a business, you decide which parameters are the most important to you and we will guarantee you a solution that is optimally suited to your needs and your customers' wishes.



“How can I achieve a higher turnover?”

With a car wash finish that exceeds all expectations.

A car wash isn't always a car wash. The same goes for cleanliness: some differences aren't spotted until you inspect problematic zones such as the rear and the wheel rims, or until the vehicle's paintwork starts to deteriorate in the long term.

The EasyWash not only meets your customers' expectations, it exceeds them with highly efficient washing chemicals and technical features, providing a car wash finish that is sure to impress whilst selling at higher average prices at the same time.



## Best performance technology for optimal cleaning.



### SofTecs® Pur:

#### Gentle and safe on paintwork and surfaces.

Developed from our successful SofTecs® material, SofTecs® Pur is especially gentle and safe on paintwork and surfaces. Thanks to a higher rotational speed and longer contact with the vehicle, SofTecs® Pur achieves an even more effective cleaning with improved results. The brushes are available in a variety of colours and colour combinations.



#### Wheel cleaning for shiny wheel rims.

- Special wheel cleaning brushes clean wheel rims thoroughly
- Optionally available with high pressure

## Best performance chemicals for shine and protection.

### Targeted application of chemicals:

#### For optimum results in all areas.

The best chemicals only work properly when their application is targeted. In the EasyWash system, the washing chemicals used always reach exactly where they are needed.



### FoamTecs:

#### The active foam for optimal cleaning performance.

FoamTecs active foam guarantees a gentle main wash no matter the water quality whilst providing optimum cleaning results. Active substances within FoamTecs remove even tough dirt reliably by coating dirt particles so that these are easily washed away.



### DryTecs®:

#### Chemical drying assistance.

DryTecs® innovative composition guarantees a perfect drying result on all varnish and glass surfaces. With DryTecs® the water film disperses easily and quickly, forming single water drops on the hydrophilic surface.

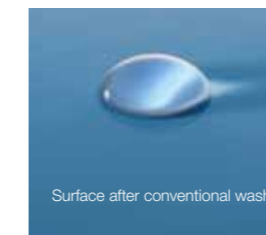

Surface after conventional wash

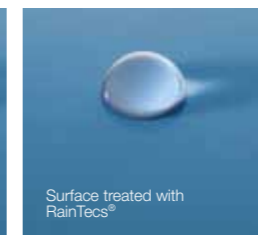

Surface treated with RainTecs®

### RainTecs®:

#### The formula for maximal roll-off effect.

Drivers get twice the benefit from RainTecs® care: the roll-off effect on the windscreen means significantly improved visibility in rain, and RainTecs® also protects the car's paintwork from harsh weather and environmental influences.

### AUWA chemicals:

#### The success formula for your car wash business.

Washing chemicals from AUWA are the optimal complement to WashTec systems. As a full subsidiary of WashTec, AUWA has over 40 years of experience in the car wash business. Like no other provider, AUWA knows the needs of businesses and their customers and consistently gears its products and services towards these.





**“More washes in the same amount of time – is this possible?”**

---



**Innovative wash solutions create more throughput and greater revenues.**

---

Time is money, even – and especially – in the car wash business. For one, your customers want to clean their cars quickly and, for another, as a business you know that the quicker the wash, the greater your throughput – and your turnover.

The EasyWash gantry car wash offers effective ways to increase your throughput, e.g. by providing you with a variety of technical features.

# The fastest machine in its class.



**EasyWash:**

**The fastest gantry car wash system for your successful car wash business.**

- Contour-following drying procedure via light barriers or memory control
- Increase your revenue with a higher throughput
- Frequency-controlled systems for lifting and pushing movements

- 1 Direction of movement
- 2 Lifting motion roof brush
- 3 Lifting motion dryer

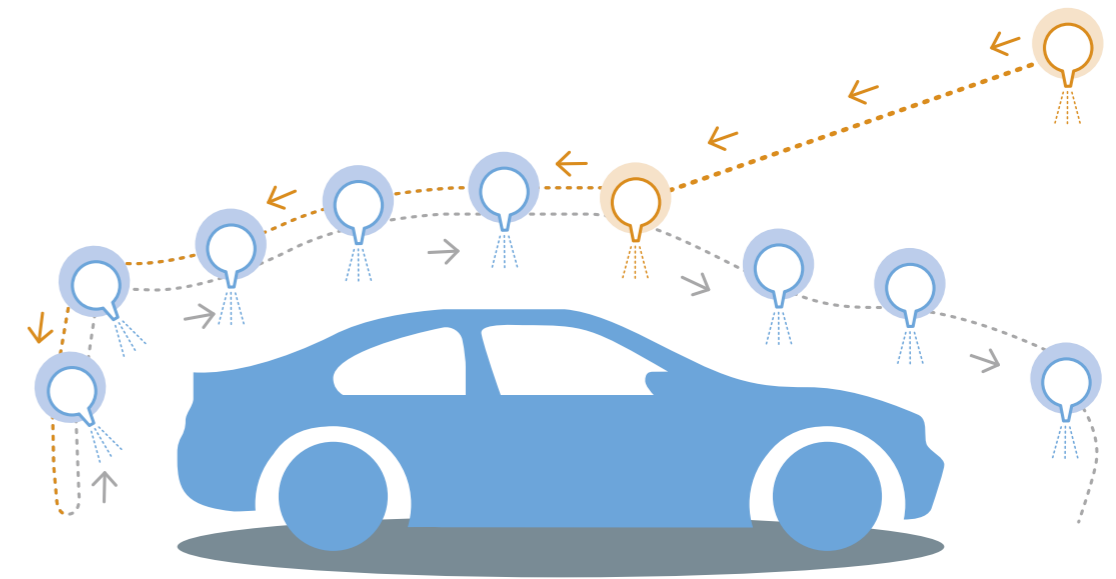

**Fly-in: For faster drying.**

The programme's contour memory function accelerates the drying procedure as the dryer moves down faster towards the roof of the vehicle. The result: less time needed for washing and satisfied customers.



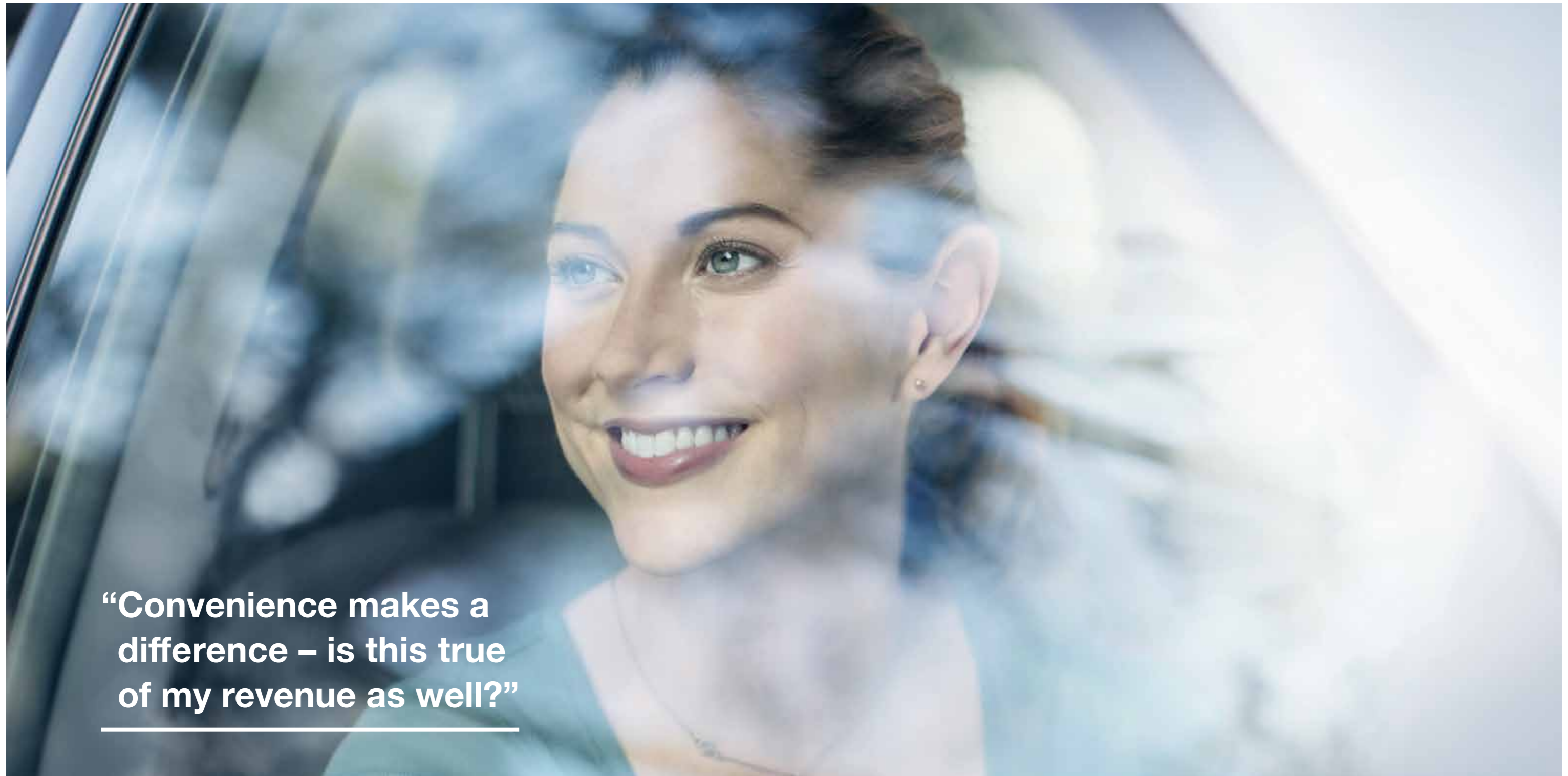

**“Convenience makes a difference – is this true of my revenue as well?”**

**Smart solutions for easy operation and payment.**

Car wash customers want to have it as simple and comfortable as possible. They don't want to bother with a complicated handling and a complex payment process. Instead, what they want is Convenience with a capital C combined with a high degree of individuality.

With EasyWash, you can now offer your customers a new dimension of convenience. Starting off with a simple handling and ending with the Wash&Pay concept, you can show your customers that you take their requests seriously so that they'll enjoy coming back to you.



# More convenience for happy customers.

## Wash&Pay



### Wash&Pay: Wash first, pay later.

Drive in, get the car cleaned and pay later – with Wash&Pay, getting the car washed is just like refuelling. The customer drives directly into a free gantry and can pay conveniently either during or after the car wash process, saving time and eliminating the need to get out and in unnecessarily.

## Touch operating terminal



### Touch operating terminal: Convenient programme start.

The extra-convenient operating terminal. Your customers can use the touchscreen for quick and easy selection of their car wash payment and programme start, and can even do so right from the driver's seat if required. They can use the selection function to choose for themselves whether they would like to get out of the car before the wash or remain inside.





**“Do all car washes have to look the same?”**

---



**Design a more appealing car wash experience for your customers.**

---

Customers know a special car wash when they see it – from the appealing look of the machine and the modern design. EasyWash provides a visual experience that continues even during the wash programme – it will surprise both you and your customers.

The great thing about having a modern design is that not only does it look nice, it also pays off for you: experience has shown that customers are willing to pay higher prices for high-quality products and services that also look good.





# Ideas for your unique appearance.

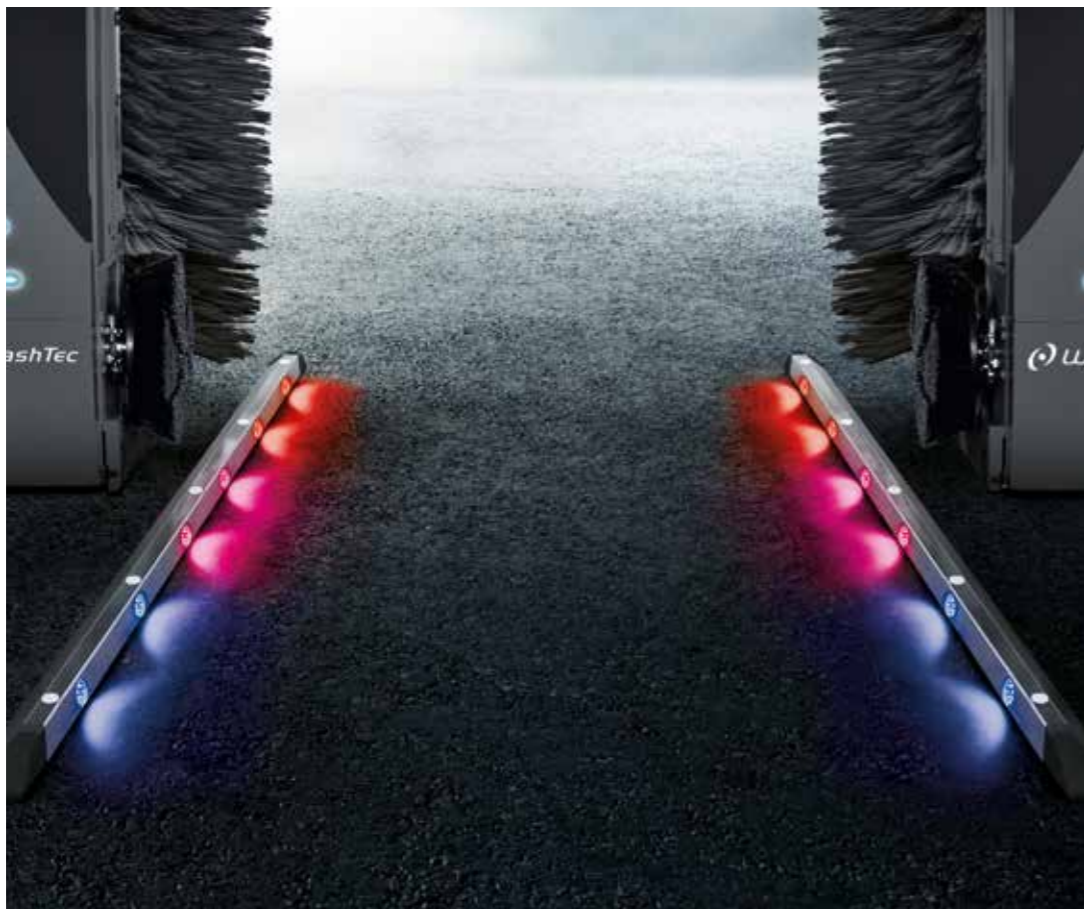

### StarTrack guide rails:

#### Attractive markers leading into the car wash gantry.

The innovative StarTrack guide rails light up to show your customers the way into the gantry. The variable lighting pattern and change of colour based on the process (drive-in, positioning, wash programme start) allow the customer to see immediately when the car is in the correct position, for example. The LED lighting of the guide rails creates a unique lighting ambiance during the car wash process.



# EasyWash designs: Premium at first glance.

There are a number of different design variants, lighting and display elements you can use to design your system. Select one of WashTec's appealing designs or adapt your system in colour and motif to suite your company's brand. Machines can be ordered in almost every RAL colour and the brushes are available in many different colours and combinations.

### Perfect dimensions to maximise your business.

Adapt your EasyWash system to suit the height of your car wash area. You can choose from four washing heights between 2 m and 2.90 m – the perfect dimensions for modern vehicles. The standard washing width is 2.48 m.

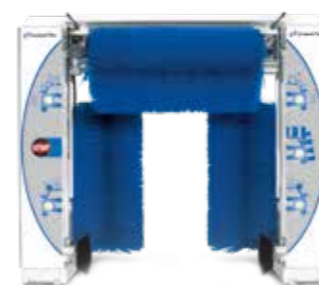
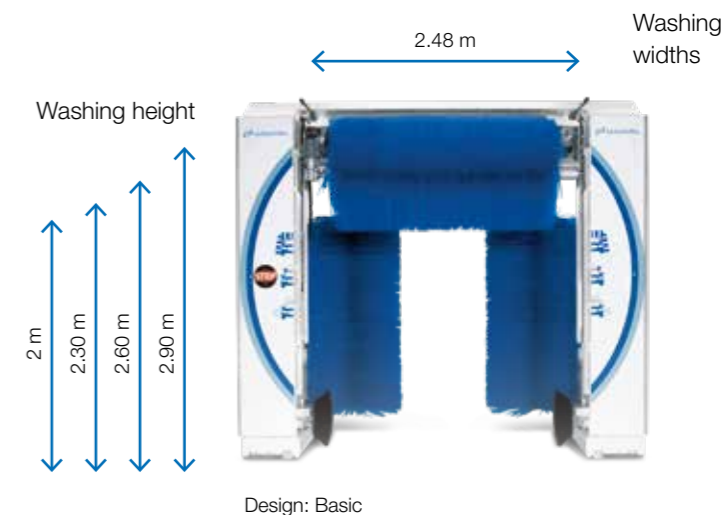

Design: Plus



### Individual colour scheme for your system.

Choose from a variety of colours and special colours (upon request).

	RAL 1003 Signal yellow		RAL 5005 Signal blue		RAL 5022 Night blue		RAL 7012 Basalt grey
	RAL 1013 Oyster white		RAL 5012 Light blue		RAL 6018 Yellow green		RAL 9010 Pure white
	RAL 2004 Pure orange		RAL 5013 Cobalt blue		RAL 6029 Mint green		RAL 9018 Papyrus white
	RAL 3020 Traffic red		RAL 5015 Sky blue		RAL 7035 Light grey		
	RAL 5002 Ultramarine blue		RAL 5017 Traffic blue		RAL 7045 Telegrey 1		



# Equipment details and accessories.

## The perfect complement to your car wash business.

Take advantage of all of the possibilities available in the car wash business by offering your customer an extensive range of add-on services. Whether vacuum cleaners, floor mat cleaners, spray equipment or money-changing machines are involved, WashTec has lots of options for you.



### Optional care for your customers. More revenue for you.

- Use care programmes as an upgrade to secure your customers' loyalty, win over new customers and generate more revenue
- The EasyWash system can be equipped with an optional wax or foam wax system



### High-pressure wash: Clean all around.

- The perfect equipment for every configuration
- Several pressure stages from 16 to 70 bar; rotatable to reach front and rear
- Flat water jets, swivelling water jets and turbo water jets available
- Integrated in the sides of the gantry and in the ceiling dryer to follow the contours of each vehicle

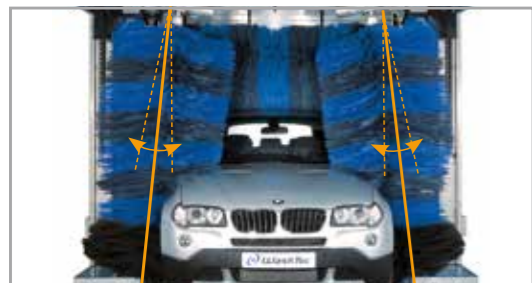

### Flex Control and SofTecs®: Clean all around.

- Large washing brush diameters combined with the Flex Control system as a standard
- Side brushes move closely to the vehicle during every wash
- Adapt automatically to the vehicle's contours



### Pivoted ceiling jets for an improved drying result.

- Ceiling jet optionally pivoted
- Perfect drying results at the front and the rear
- Contour-guided



### Extra business with underbody washes.

- Underbody washing is a service in high demand, especially in winter and spring
- Economical operation thanks to segment control for targeted washing of short vehicles
- Ideal service for customers who want their car to retain its value with the best care possible



### Pre-spray equipment: Complete your clean service.

- Optimal finish thanks to perfect pre-washes
- Easy and targeted application by the customer
- Perfect for integration in the 'waiting zone' at the front of the car wash
- Ideal for additional turnover



### Vacuum cleaner.

- Optimal for making use of 'empty space'
- Additional turnover boost
- Opportunity for customer retention strategies, such as inclusion as an upgrade service in promotions



### AquaPur: An efficient and profitable water recovery system.

- The most efficient way to save money and protect the environment
- Virtually 100% of washing water is recovered
- Up to 600 washes per month possible without needing to add more chemicals



# Control and operation made easy.

Car wash customers want a straightforward easy process, especially when it comes to operating your washing system. WashTec offers a number of operating terminals, available with a keypad or touchscreen. Select from various configurations and payment systems, such as those involving wash tickets, transponder cards or payment by credit card.



**Maximum cost efficiency:  
Control terminal standard.**

- Wall-mounted terminal
- Start wash programmes with user-friendly code entry on the keypad
- MultiBox²: user-friendly code output for your office



**Intuitive operation: Control terminal with code.**

- Attractive terminal mounted on the wall or on a pedestal
- Easy code entry on the keypad
- MultiBox²: user-friendly code output for your office
- Individual operating mode with or without cable connection



**Optimal combined solution:  
Control terminal with code + card.**

- Combined solution that suits every situation – single wash using a code with registration
- Your customers can choose between ‘Multi’ and ‘Cash’ wash cards in the form of durable transponder cards that never expire
- MultiBox²: system-integrated code output and programming of transponder cards for easy, flexible handling



**Elegant solution for extremely easy operation:  
Control terminal with code + scan.**

- Easy system operation with wash tickets and scanner
- Your customers can choose between ‘Single’, ‘Multi’ and ‘Cash’ wash tickets
- MultiBox²: user-friendly code output for your office as a printout with a barcode



**Convenient programme start:  
Interactive touch operation.**

- Your customers can use the touchscreen for quick and easy selection of their car wash, payment and programme start
- Easy operation thanks to intuitive graphical user interface
- Innovative system – and a necessity for new concepts like iWash and Drive-In



**Internet connection for the perfect overview.**

- With WashTec Plus, you are in a great position to get perfect overviews and reporting as a multi-site operator
- Machine counters and ACS fill levels are easy to view and configure online
- Flexible access via smartphone, tablet and/or PC



# “How can I unlock the full potential of my car wash business?”

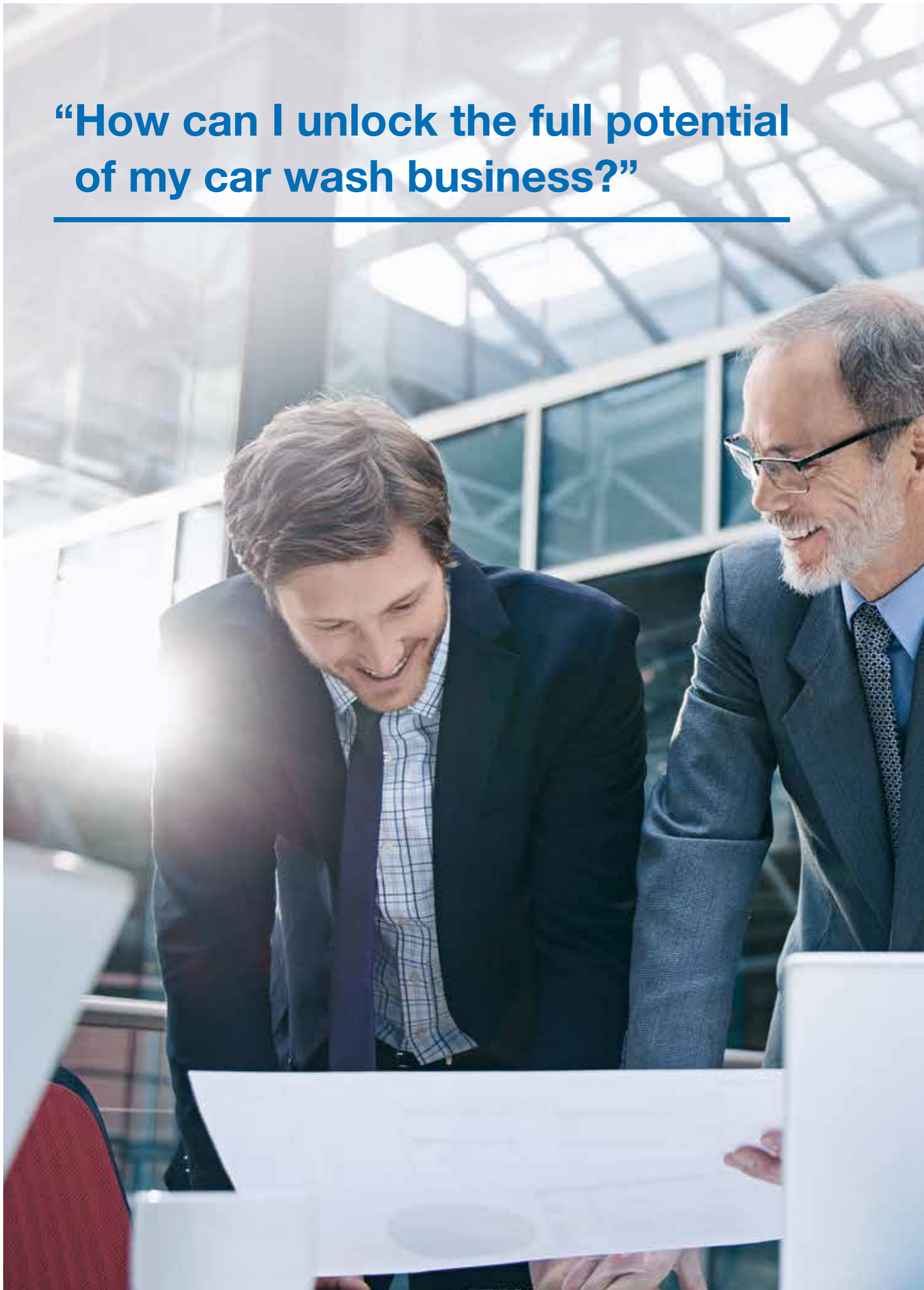

# With WashTec’s comprehensive service package.

The success of your car wash business is decided long before you open for business. WashTec supports you through the entire process, from initial planning and financing to running operation.

As a market leader in the car wash industry, we know what your successful business depends on and offer a comprehensive range of services from a single source. The EasyWash not only provides an entirely new experience for your customers, but also for you.

### Competent planning: The basis for your successful business

Every car wash site is different, just as each car wash clientele has specific requirements. We help you to choose and configure the right EasyWash gantry car wash for you. If desired, we can also take on site planning and potential analysis, giving you a solid basis for a successful business.

### WashTec Marketing: Ideas for optimal success

A successful car wash business also needs powerful marketing. We can provide you with support in this area from day one onwards, from conducting site and target market analyses to developing a marketing concept just for you, supporting you as it is implemented and helping you to monitor its success afterwards. We offer a number of advertising media that can be used to attract new customers and appeal to existing customers.

### WashTec Financial Services: Your go-to for finance

WashTec Financial Services is your first contact when it comes to financing your system. Whether you are interested in leasing or a hire-purchase scheme, we can provide individual advice and find the best solution for you with a contract that is precisely tailored to suit your needs. We also help you to draw up a profitability calculation and offer attractive terms and conditions.

### Maintenance and support: Service the way you need it

Downtime costs time and money. That’s why keeping your car wash in smooth running order is our top priority. Our maintenance concepts are tailored to your individual needs and ensure constant availability of your system. And if you do hit a snag, our service network with experienced employees provides you with perfect support using state-of-the-art commercial vehicles and online management systems.